

www.quallight.com
E-mail: sales@quallight.com
Tel: (914)912-0266



QUAL LIGHT[®]
U.S.A

 **QUAL LIGHT**[®]
U.S.A

Film Reflective Illuminating System & Key Magnet

FILM REFLECTIVE ILLUMINATING SYSTEM

Crafted for perfect optical performance.
Unmatched efficiency of your lighting system.
Versatility and customization in a variety of designs
and materials to suit a wide range of applications.

Pioneer of Lighting Technology

We are dedicated to shaping the future of lighting technology.
Our vision is to empower our customers with high-quality lighting solutions that provide exceptional optical and light control. We believe that light is not just a source of illumination; it's a tool that can transform spaces, enhance experiences, and inspire innovation.

REFLECTOR PANEL

Versatile Surface Colors:

Choose from six distinct surface colors to achieve different lighting designs and effects



G0

Warm light



S0

Mirror reflection



S1

Hard spotlight



S2

Medium diffusion



S3

Soft diffusion



S4

Natural-like light



DW #5

Linear light

- **Diverse Applications:** QUAL LIGHT Reflectors come in various sizes and colors, suitable for a wide range of lighting scenarios, from small spaces to large architectural installations.
- **Aluminum-Coated Surfaces:** QUAL LIGHT Reflectors are made with aluminum-coated materials for precise and efficient light reflection, enhancing durability during transport.
- **Optical Manipulation:** The different surface options empower lighting designers to control light for various effects, including color temperature and diffusion, making them valuable tools in lighting design.

Multiple Sizes:

QUAL LIGHT Reflectors are available in five different sizes, catering to a variety of lighting needs



7*7cm



15*15cm



25*25cm



50*50cm

100x100cm Reflector

A large reflector designed for on-location shooting, capable of providing even lighting that can transform an entire room. When used in combination with a tall tripod, you can achieve the desired lighting effect from any position.



100*100cm

REFLECTOR APPLICATIONS

QUAL LIGHT Reflectors offer endless possibilities for creative lighting solutions. Explore the world of precise light control and optical design with our diverse range of sizes and surface colors. Illuminate your vision with QUAL LIGHT.



G0, S0 ~ S4
Effect video



G0

Warm reflective surface
Ideal for creating a soft, dusk-like glow.



S0

Primary color reflective surface
Generating sharp-edged, high-contrast beams.



S1

Primary color light mist surface
Preserving distinct hotspots with soft-edged beams.



S2

Primary color matte surface
Offering slightly diffused beams with high brightness.



S3

Primary color heavy matte surface
Producing beams with soft, blurred edges and lower brightness.



S4

White coated surface
Ideal for creating a natural light effect.



DW #5

Directional diffusion surface
Reflected light creating a vertical beam.



DW#5
Effect video

REFLECTOR KIT



Optional flight case with wheels and handle is also available.



MULTI KIT PRO

20 pcs in total - one piece of per type

- 7*7cm-FRIS(S0/1/2/3/4),5pcs
- 15*15cm-FRIS(S0/1/2/3/4),5pcs
- 25*25cm-FRIS(S0/1/2/3/4),5pcs
- 50*50cm-FRIS(S0/1/2/3/4),5pcs

- Grip Pro Kit:**
- 3×Roller Grip Male
 - 1×Roller Grip Female
 - 1×Safety Wire
 - 1×Bag

- Clean Kit:**
- 1×Cleaning Cloth
 - 1×Bag

- Size: 60(L) x 30(W) x 67(H)
- Gross Weight: 21 kg
- Net Weight: 19 kg



Optional flight case with wheels and handle is also available.



MULTI KIT

16 pcs in total - one piece of per type

- 7*7cm-FRIS(S1/2/3/4),4pcs
- 15*15cm-FRIS(S1/2/3/4),4pcs
- 25*25cm-FRIS(S1/2/3/4),4pcs
- 50*50cm-FRIS(S1/2/3/4),4pcs

- Grip Pro Kit:**
- 3×Roller Grip Male
 - 1×Roller Grip Female
 - 1×Safety Wire
 - 1×Bag

- Clean Kit:**
- 1×Cleaning Cloth
 - 1×Bag

- Size: 60(L) x 30(W) x 67(H)
- Gross Weight: 18 kg
- Net Weight: 16 kg

PANEL EXPANSION KIT

This kit includes four reflector panels, enhancing the capabilities of your professional lighting set up.



7 Kit

7*7cm- FRIS (S1/2/3/4), 4pcs
1×Cleaning Cloth



15 Kit

15*15cm- FRIS (S1/2/3/4), 4pcs
1×Cleaning Cloth



25 Kit

25*25cm- FRIS (S1/2/3/4), 4pcs
1×Cleaning Cloth



50 Kit

50*50cm- FRIS (S1/2/3/4), 4pcs
1×Cleaning Cloth

7 Kit-4X/5X

7*7cm- FRIS, 4 or 5pcs (Free combination)
1×Cleaning Cloth

15 Kit-4X/5X

15*15cm- FRIS, 4 or 5pcs (Free combination)
1×Cleaning Cloth

25 Kit-4X/5X

25*25cm- FRIS, 4 or 5pcs (Free combination)
1×Cleaning Cloth

50 Kit-4X/5X

50*50cm- FRIS, 4 or 5pcs (Free combination)
1×Cleaning Cloth

Double Side Frame 100×100 Reflector

100×100cm reflector kit
Designed for dual-sided use. For convenient setup
and compatibility with a tripod.

Reflector with 4 corner tie ropes for angle adjustment.
You can also choose to pair it with an additional **Auto Yoke** for remote operation.

1pc reflector in total, two-side with yoke

100*100cm-FRIS (Include Cleaning Cloths×1)

TF-100 Reflector comes with two options to choose from:

KBR-100SOS1 (1pc)

KBR-100S2S3 (1pc)

Double side reflector:

Double side reflector:

Diffusion S0

Diffusion S2

Diffusion S1

Diffusion S3

Surface color can be customized according to needs:
(S0/S1/S2/S3/S4/G0)



TF100 KIT

TF100-KIT (2pcs with flight case, TF100-01 & TF100-23)

1×KBR-100SOS1
1×KBR-100S2S3
1×FLIGHT CASE



- Size: 135(L) x 22(W) x 127(H)
- Gross Weight: 88 kg
- Net Weight: 45 kg

ACCESSORIES

GRIP KIT

Grip Kit - Pro



- 3×Roller Grip Male
- 1×Roller Grip Female
- 4×Safty wire
- 1×Bag

Grip Kit



- 1×Roller Grip Male
- 1×Safty wire
- 1×Bag

Roller Grip

16mm Pin & 16mm Receiver, in combination with magic arms and magic legs, you can freely assemble the reflector layout.

16mm



GRIP-F

GRIP-M

Safty Wire : SW-P75

Featuring 2.0mm, diameter with a 7x7 wire configuration. Supports a weight of 5kg. This cable is constructed using galvanized steel wire. The cable sheath is made of transparent PVC and one end is equipped with a black spring hook to ensure the safety of your equipment.



CLEAN KIT

Specialized cleaning cloth for reflector panel surfaces and an 80ml cleaning solution bottle are included in the accessory kit, making it easy to carry and store.



- 2×Cleaning Cloth
- 1×80ml Bottle(empty)
- 1×Bag

Clean Cloth

25x25cm reflector cleaning cloth for precision care.



AUTO YOKE

When elevating the TF100 on a stand, you can effortlessly and safely adjust the reflector panel angle using a remote control device, eliminating the need for frequent lifting and lowering of the stand to achieve the desired lighting.



Scan the QR code for more information.



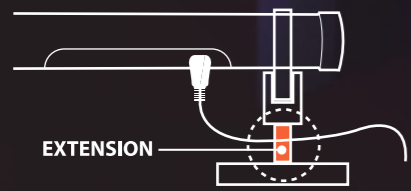
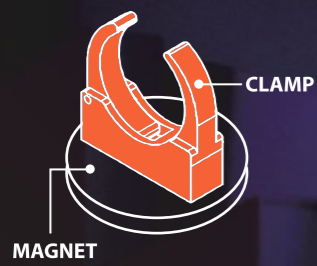

Place magnets on ends of Astera Tubes for best result.

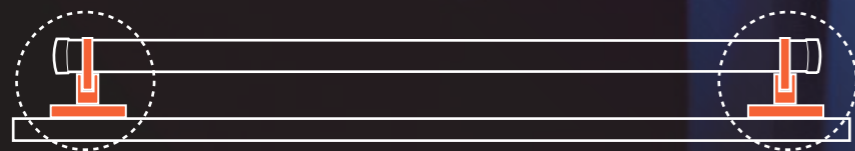

Using magnetic disks, you can quickly and flexibly mount lighting equipment on metal walls or pipe brackets. The strong magnets provide reliable stability.









KEY MAGNET

MAGNETIC KIT

MAGNETIC 32 KIT WHITE











Color White ○

-  32×Magnet Large White
-  16×Large Plate White
-  16×Extension Screw Large Stainless Steel
-  16×Extension Screw Small Stainless Steel
-  32× 1/4''-20F & 1/4''-20M Screw Adapter Stainless Steel
-  8 × 1/4''-20F & 3/8''-16M Screw Adapter Stainless Steel
-  2 × Wrench
-  2 × Pull Handle Plastic
-  1 × Qual Light K32 Case

MAGNETIC 32 KIT BLACK



Color Black ●

-  32×Magnet Large Black
-  16×Large Plate Black
-  16×Extension Screw Large Stainless Steel
-  16×Extension Screw Small Stainless Steel
-  32× 1/4''-20F & 1/4''-20M Screw Adapter Stainless Steel
-  8 × 1/4''-20F & 3/8''-16M Screw Adapter Stainless Steel
-  2 × Wrench
-  2 × Pull Handle Plastic
-  1 × Qual Light K32 Case

MAGNETIC 16 KIT WHITE

















Color White ○

MAGNETIC 16 KIT BLACK



Color Black ●

-  16 × Magnet Large White
-  8 × Large Plate White
-  8 × Extension Screw Large Stainless Steel
-  8 × Extension Screw Small Stainless Steel
-  16 × 1/4''-20F & 1/4''-20M Screw Adapter Stainless Steel
-  4 × 1/4''-20F & 3/8''-16M Screw Adapter Stainless Steel
-  2 × Wrench
-  2 × Pull Handle Plastic
-  1 × Qual Light K16 Case

-  16 × Magnet Large Black
-  8 × Large Plate Black
-  8 × Extension Screw Large Stainless Steel
-  8 × Extension Screw Small Stainless Steel
-  16 × 1/4''-20F & 1/4''-20M Screw Adapter Stainless Steel
-  4 × 1/4''-20F & 3/8''-16M Screw Adapter Stainless Steel
-  2 × Wrench
-  2 × Pull Handle Plastic
-  1 × Qual Light K16 Case

COMPONENTS



32KIT

16KIT

Plate

Plate, compact and easy to carry, features screw holes, allowing for convenient magnetic environment setup in environments lacking metal surfaces.

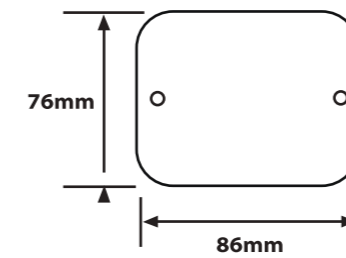

Back Adhesive

Plate is available in black and white dual colors. With a 3M adhesive on the back.

Pull Handle Plastic

Plastic handle that can be screwed onto the bolt of the magnetic disc when disassembling strong magnets, providing ample leverage for easy and secure removal.

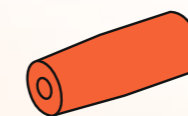

PULL HANDLE

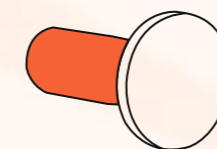

MAGNET & HANDLE ATTACHED



Magnet

Elevate your LED tube light setup with Qual Light's high-quality magnet accessories. Our strong magnets offer secure and effortless attachment, making installation a breeze.

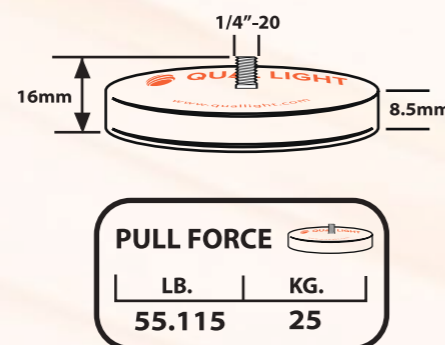
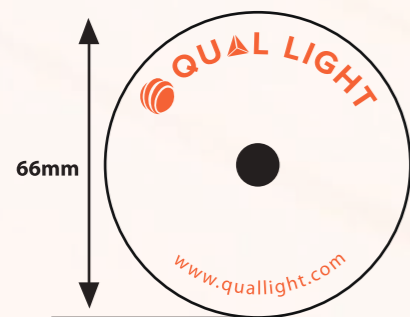

Screw Adapter & Extension Screw

Two bolt adapter heads (1/4 inch and 3/8 inch) and two bolt extension rods, compatible with various lighting fixtures, and can be freely extended based on your requirements.

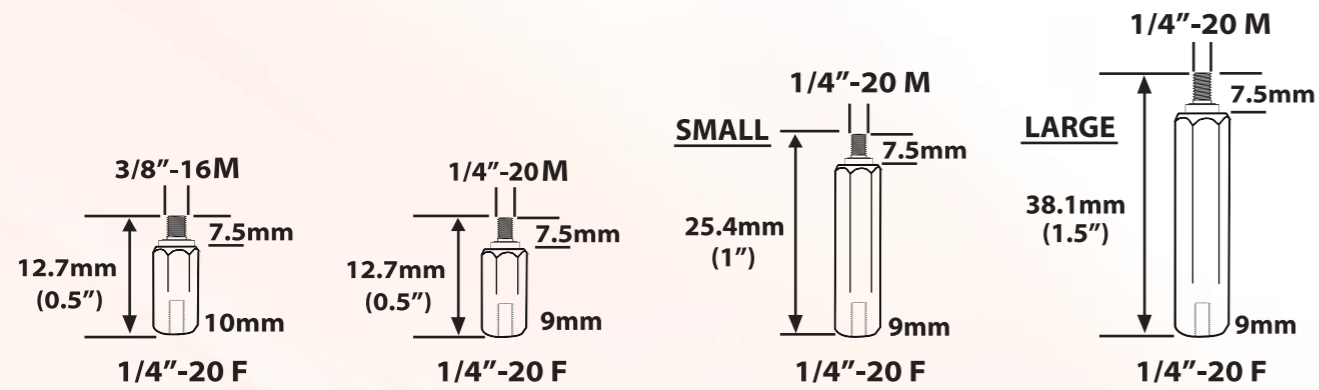

Screw Adapter

Extension Screw

Can be used to connect various lighting fixtures using magnetic disks.



Wrench

Free to combine and assemble for different lengths to meet various usage needs.

Two wrenches designed for M9 and M10 bolts in the set, facilitating the easy disassembly of bolt combinations.



1/4"-20M & 3/8"-16M
Screw Adapter Connection Assembly

1/4"-20M & 1/4"-20M
Screw Adapter Connection Assembly



removal

